

بِسْمِ اللَّهِ الرَّحْمَنِ الرَّحِيمِ



AECENAR

Association for Economical and Technological Cooperation
in the Euro-Asian and North-African Region

www.aecenar.com



مركز دراسات السياسات الاقتصادية

Institute for Economical Policy (IEP)

www.aecenar.com/institutes/iep

North Lebanon Bus Station Project

Author: Maryam Abdel-karim

Last Update: 28.03.2020

Contents

1.	BASICS	5
1.1	INTRODUCTION	5
1.2	HIERARCHY OF BUS TERMINALS	5
1.3	PLANNING CRITERIA	5
1.3.1	NEED	6
1.3.2	SIZE	6
1.3.3	LOCATION	6
1.3.4	DESIGN	6
1.4	BUS TERMINALS MAIN REQUIREMENTS	6
1.5	TYPE OF VEHICULAR MOVEMENT AROUND APPROACHING PARKING BAYS	7
1.5.1	TYPE 1: SHUNTING	7
1.5.2	TYPE 2: DRIVE THROUGH BAYS	7
1.5.3	TYPE 3: SAW TOOTH BAYS	8
1.6	BUS DIMENSIONS.....	9
1.7	BUS TURNING REDIUS.....	10
1.8	PLATFORM TYPE	11
1.8.1	PARALLEL LOADING	11
1.8.2	RADIAL SAW TOOTH LOADING	11
1.8.3	STRAIGHT SAW TOOTH LOADING	12
1.8.4	RIGHT ANGLE LOADING	12
2.	APPLICATION	13
2.1	Location.....	13
2.2	Buses Lines	14
2.3	Bus Stop.....	15
2.4	Bus Station Overview	17

1. BASICS¹

1.1 INTRODUCTION

Transportation is an integral part of the functioning of the society. The transport system improves the social, economic, industrial, commercial progress and transfers the society into an organized one. It is one of the most essential services, vital force for determining the direction of development. To achieve the desired transportation balance and the system to be efficient, it is essential to provide organized facilities in the system, one such facility is a Bus Terminal

As transportation involves the movement of the people and goods, there is a need of an “access point” in transport system to use it. These access points are known as “Terminals” or the fixed facilities. Terminals are one of the main components of any mode of transportation.

Bus terminals are predominantly used for inter-city and intra city movement because of the higher accessibility of bus terminals.

Terminals serve as a point of:

- Concentration
- Dispersion
- Loading/unloading of the passengers
- Interchange of mode
- Storage of passengers and vehicles
- Maintenance of vehicle
- Facilities and amenities for the users and crew
- Documentation of movement
- Information system
- Integration of various systems of transportation

1.2 HIERARCHY OF BUS TERMINALS

Hierarchy of Bus Terminals:

- Road based bus stop
- Road side bus bay
- Bus stop distributed
- Sub nodal terminal
- Nodal bus terminal
- Intercity bus terminal and interstate bus terminal(ISBT)

1.3 PLANNING CRITERIA

In general, the four basic planning criteria for planning of terminals are:

¹ <https://www.slideshare.net/sumiran46muz/bus-terminal-library-study>

1.3.1 NEED

NEED of the terminal arises with increase in the demand. An organized bus terminal should meet the following requirements:

- Accessibility
- Comfort and convenience
- Safety
- Easy processing

1.3.2 SIZE

The following factors are considered to characterize the size of the terminal and its functions:

- Flow of traffic
- System characteristics
- User characteristics

1.3.3 LOCATION

The selection of the location should satisfy the following criteria:

- It should form a component in the hierarchy of transport systems
- It should be a component in the hierarchical system of transportation terminals
- The concentration and dispersal costs should be minimum
- It should be located such that as point of coordination and integration between intercity and intra city transport

1.3.4 DESIGN

Following points should be kept in mind for efficient workability of terminal:

- Segregation of bus and non-bus traffic
- Segregation of pedestrian and vehicular movement
- Elimination of vehicular traffic conflict
- Segregation of pedestrian flows
- Minimum processing for the buses
- Segregation of transportation and no transportation activities

1.4 BUS TERMINALS MAIN REQUIREMENTS

- Public lockers and telephones
- Dispatch office
- Offices
- Rental space
- Waiting room
- Buffet
- Public toilets
- Kiosks

- Enquiry and booking
- Left luggage
- Lost property
- Facilities for staff
- Facilities for vehicle maintenance
- Drivers rest rooms®
- Filling station
- Security check post
- Car/auto parking
- Accommodation/DORMATORY

1.5 TYPE OF VEHICULAR MOVEMENT AROUND APPROACHING PARKING BAYS

1.5.1 TYPE 1: SHUNTING

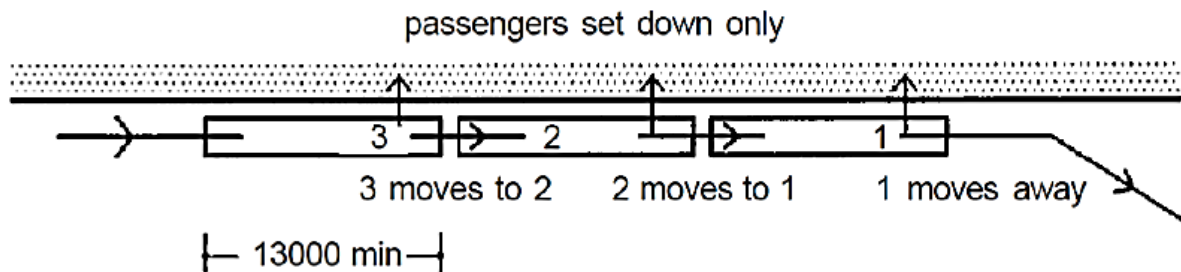

Shunting where a vehicle only sets down passengers on the concourse before moving off to park or pick up more passengers> This avoids waiting to occupy a pre-determined bay, and reduces effective journey time.

1.5.2 TYPE 2: DRIVE THROUGH BAYS

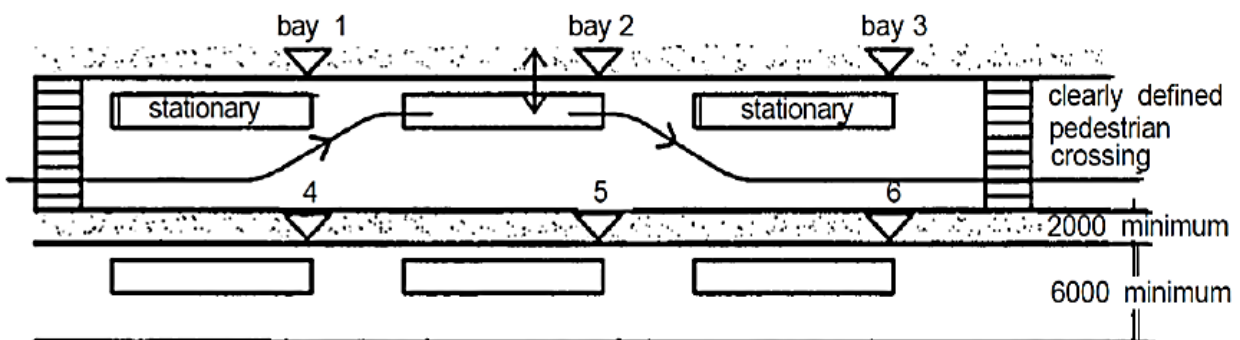

Drive-through bays are fixed positions for setting down and/or collecting passengers. They are in a line, so a vehicle often has to approach its bay between two stationary vehicles. In practice it is often necessary to have isolated islands for additional bays, with the inevitable conflict between passenger and vehicle circulation.

1.5.3 TYPE 3: SAW TOOTH BAYS

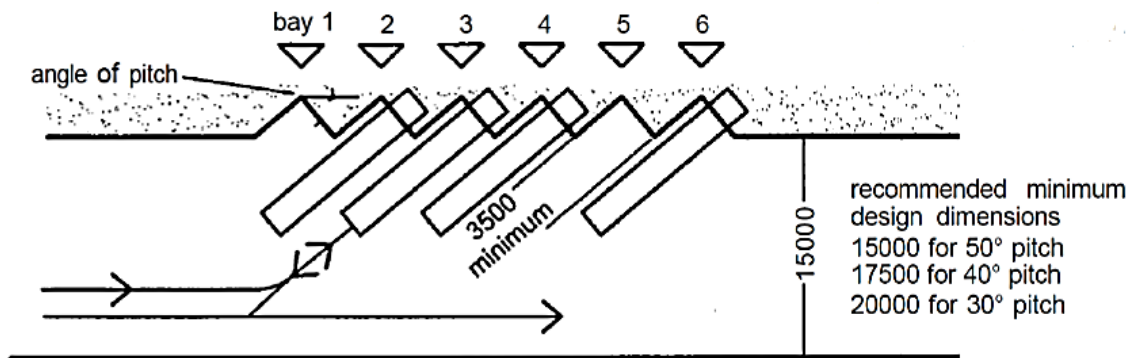

Saw-tooth layouts have fixed bay positions for setting down and/or collecting passengers with the profile of the concourse made into an echelon or saw-tooth pattern. In theory the angle of pitch between the vehicle front and the axis of the concourse can be anything from 1° to 90°; in practice it lies between 20° and 50°. The vehicle arrives coming forward, and leaves in reverse, thus reducing the conflicts between vehicle and passenger circulation, but demands extra care in reversing.

Passenger safety and control are particularly important when detailing saw-tooth bays

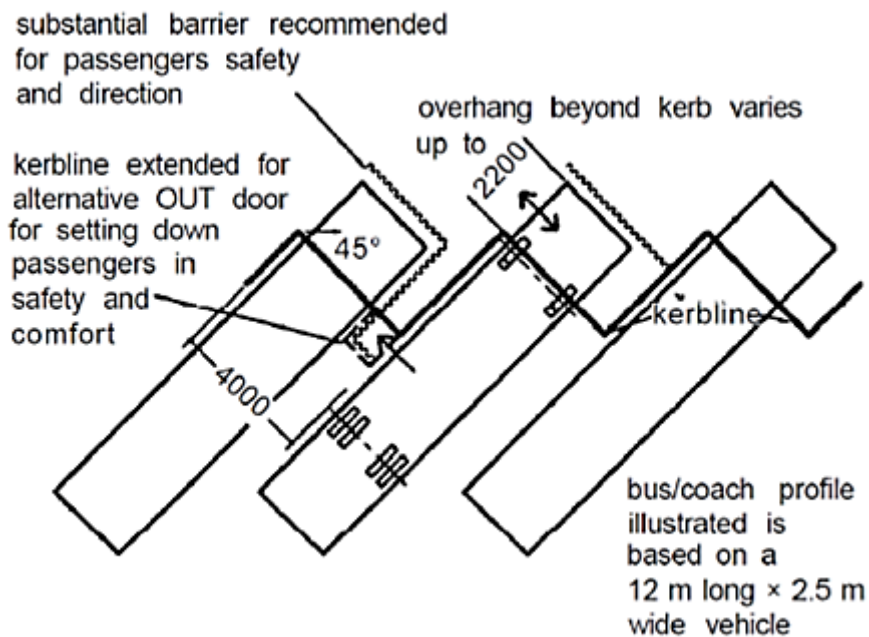

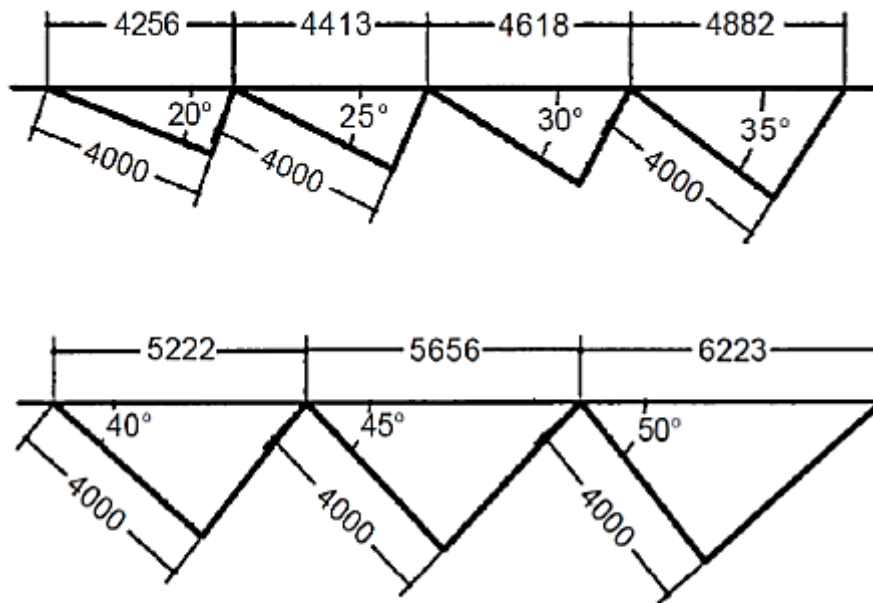

As the angle of pitch in saw-tooth bays increases so does the distance between each bay.

1.6 BUS DIMENSIONS

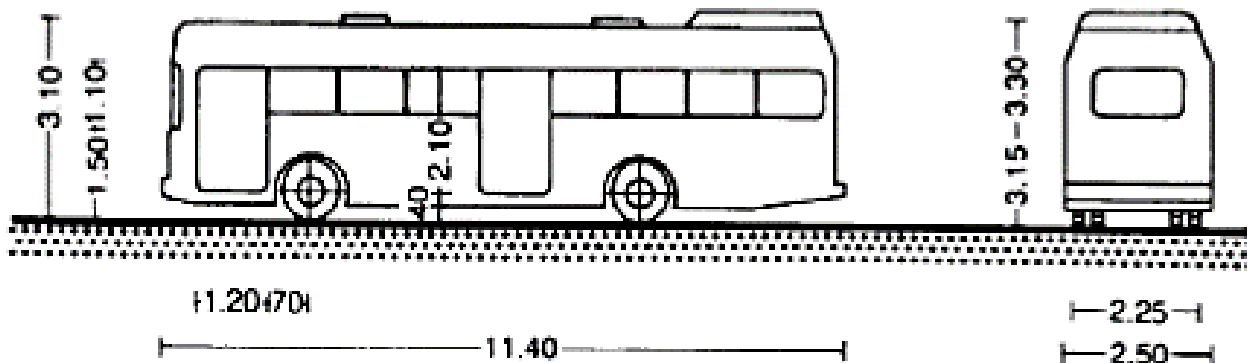

Single-decker bus

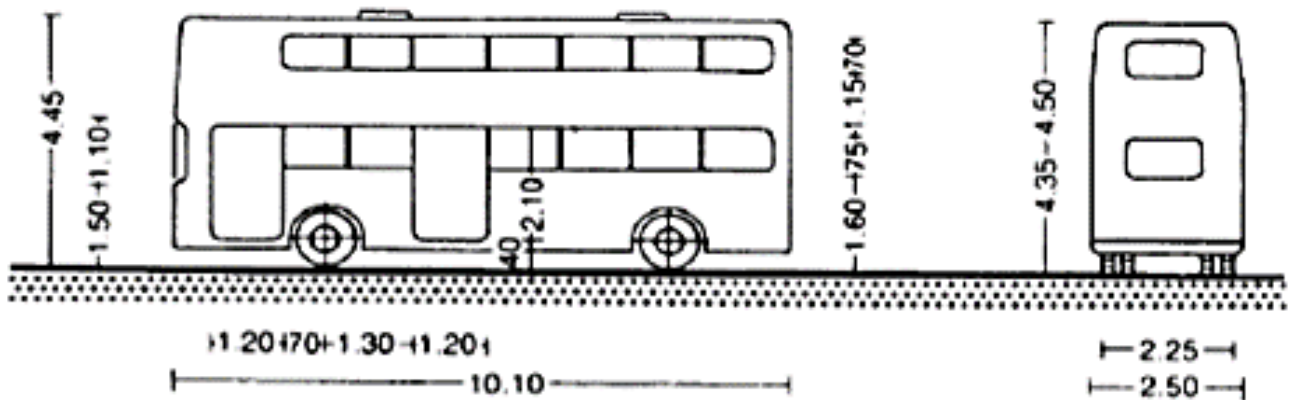

Double-decker bus

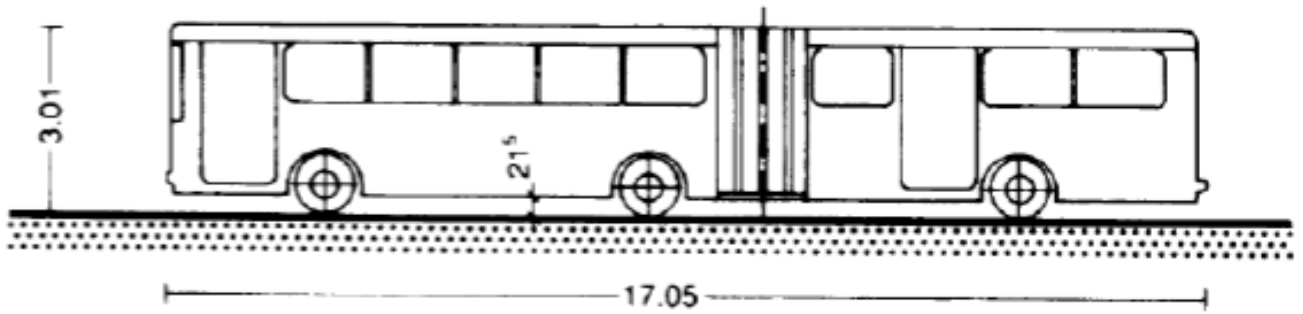

Articulated bus, common in Europe

1.7 BUS TURNING REDIUS

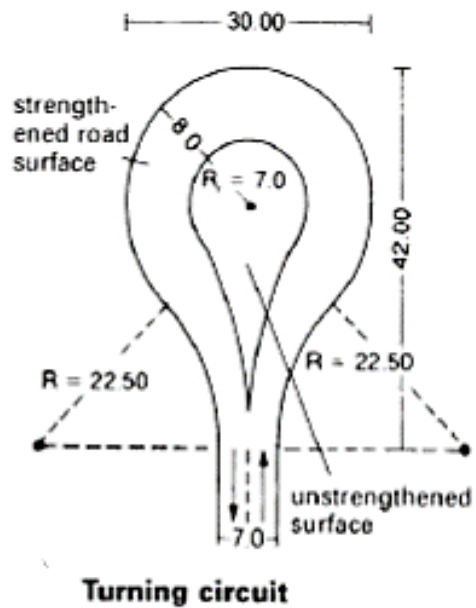
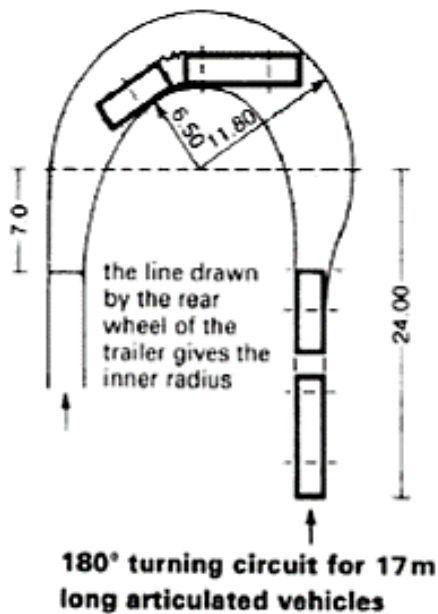
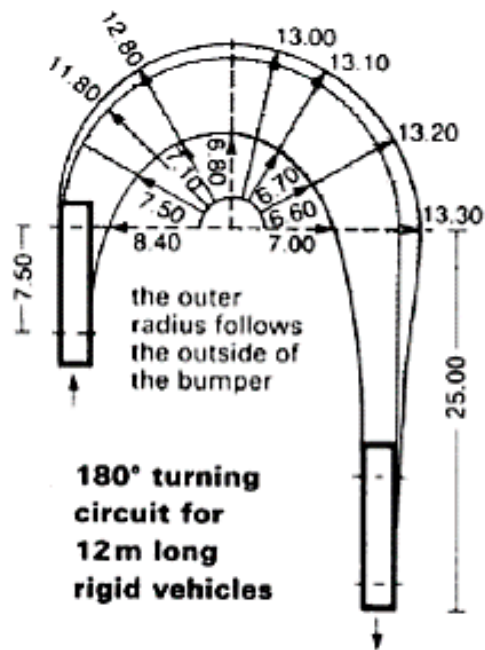
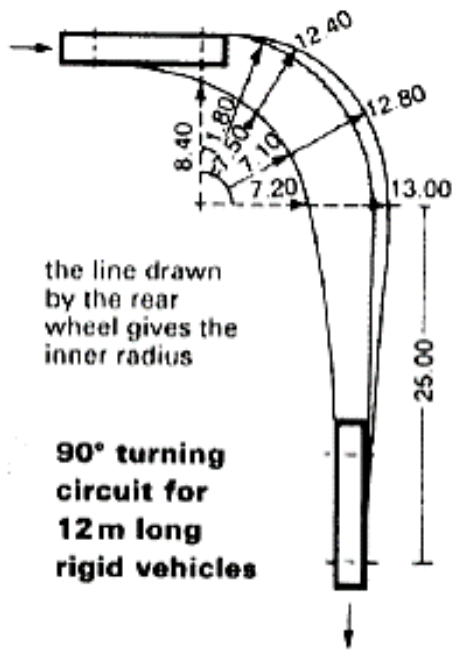

1.8 PLATFORM TYPE

1.8.1 PARALLEL LOADING

- Require excessive amount of space
- Buses must usually wait until first bus exits
- Large terminal requires pedestrian under/overpass facilities to protect passengers while crossing lanes

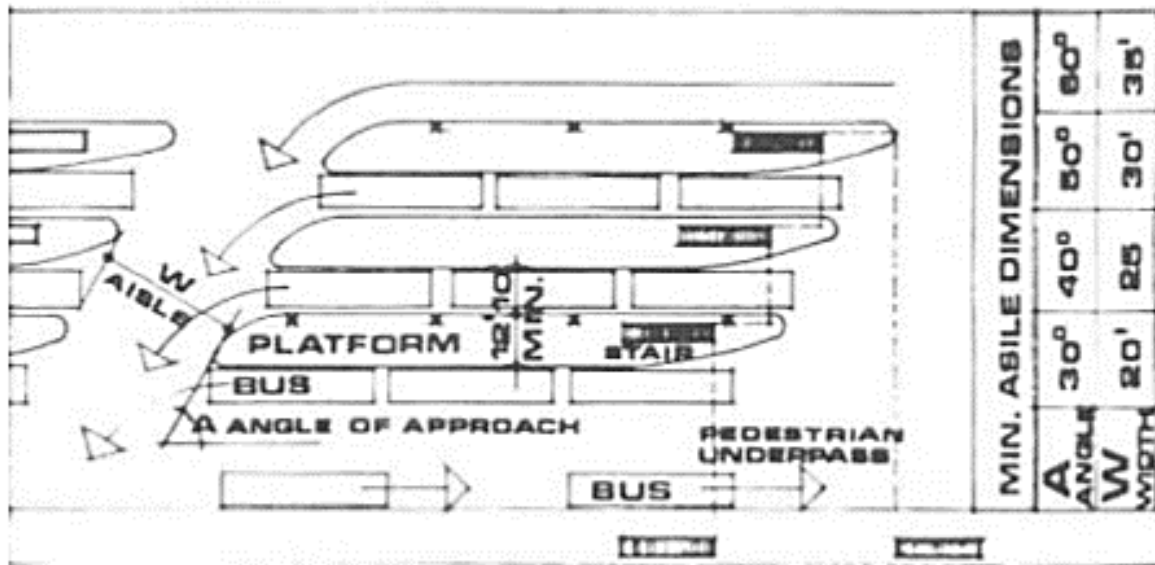

PARALLEL SINGLE LANE ISLAND

1.8.2 RADIAL SAW TOOTH LOADING

- Most efficient-buses swing into position along natural driving arc
- Space required at front is minimum-wide space at rear making maneuvering easy

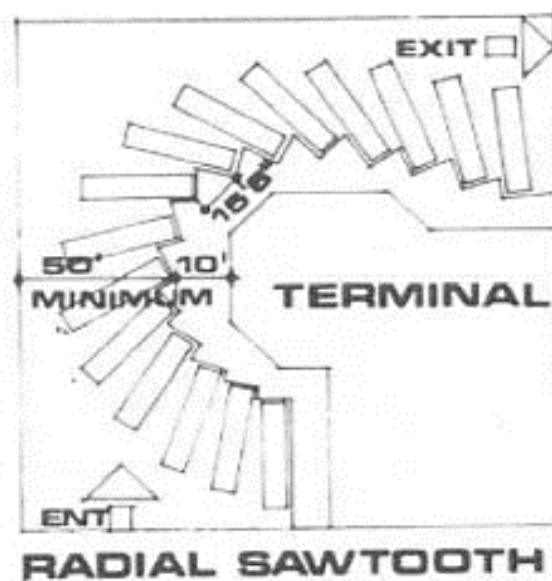

RADIAL SAWTOOTH

1.8.3 STRAIGHT SAW TOOTH LOADING

- Efficient –employed where lot is comparatively narrow and deep
- Passenger has direct approach to loading door
- Baggage truck can operate between buses for side loading

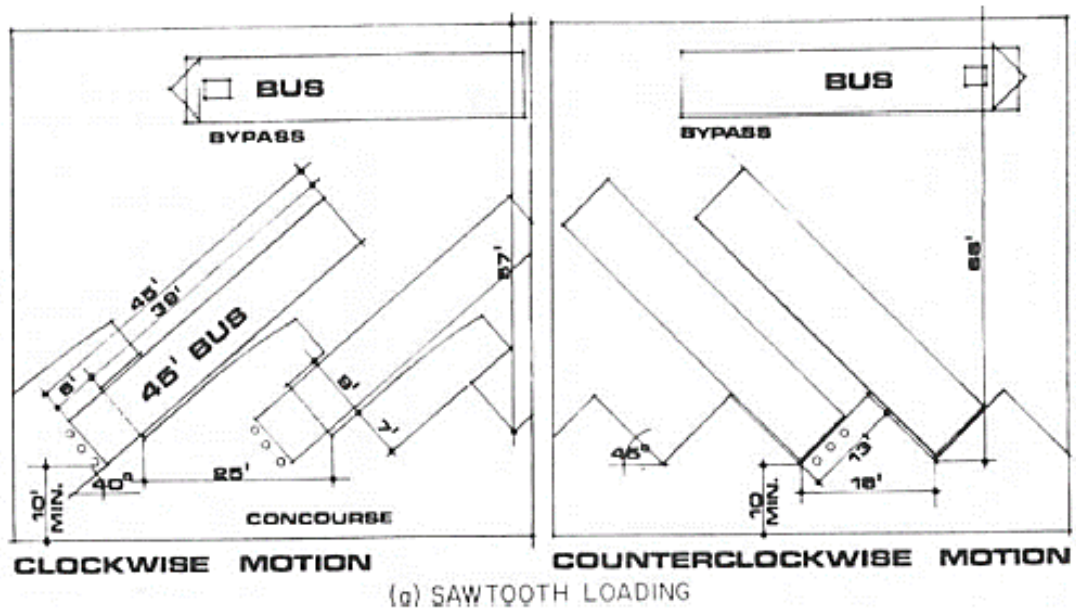

1.8.4 RIGHT ANGLE LOADING

Disadvantages include:

- Out swinging bus door which forms a barrier around which passenger must pass.
- Bus maneuvering difficult

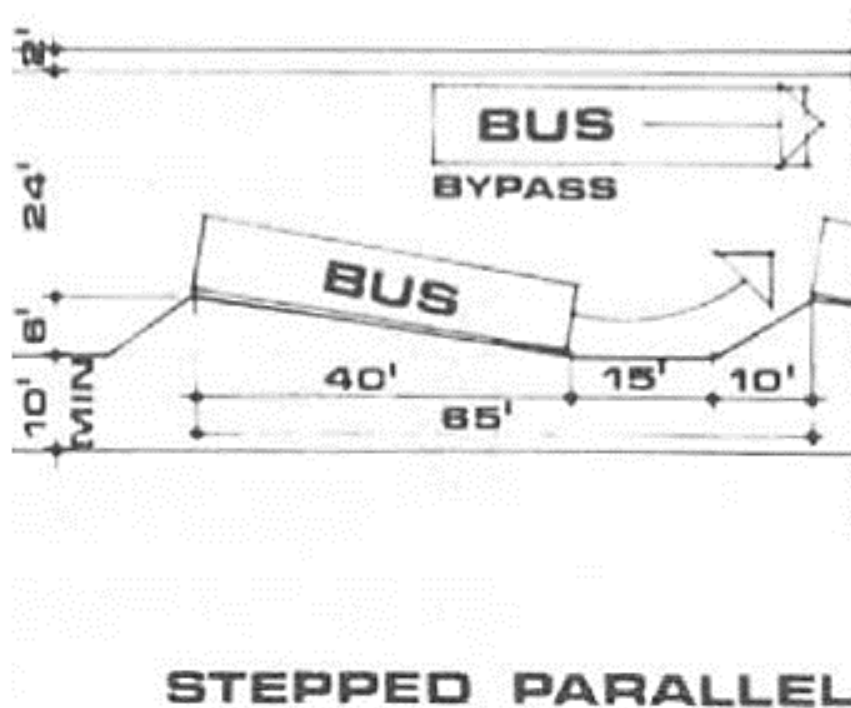

2. APPLICATION

2.1 Location

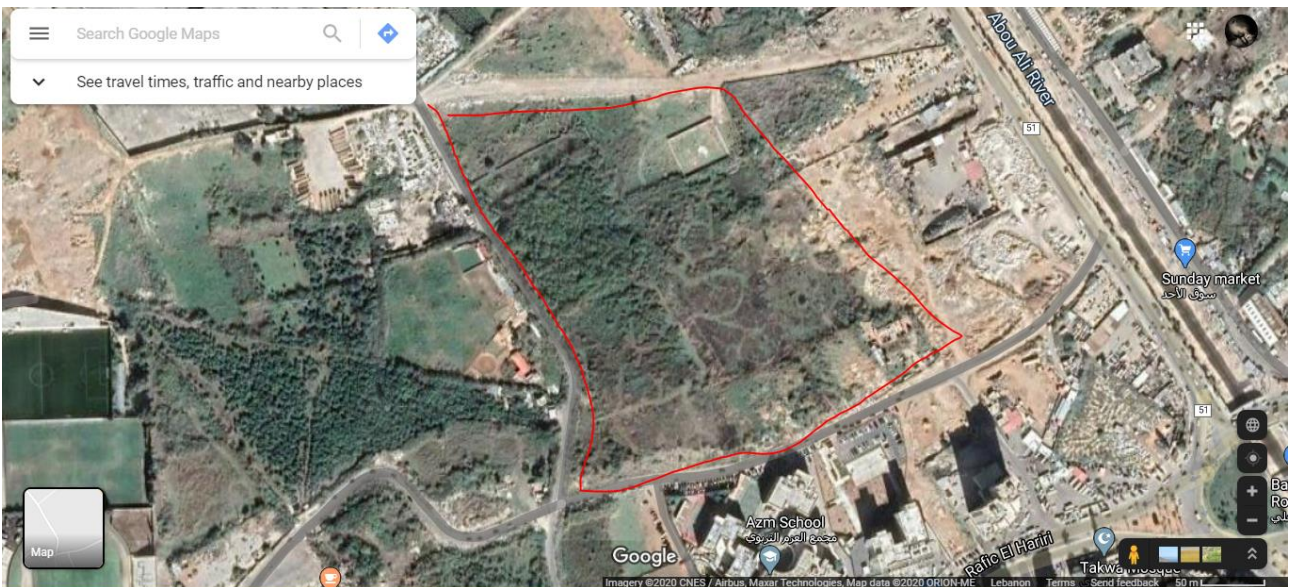
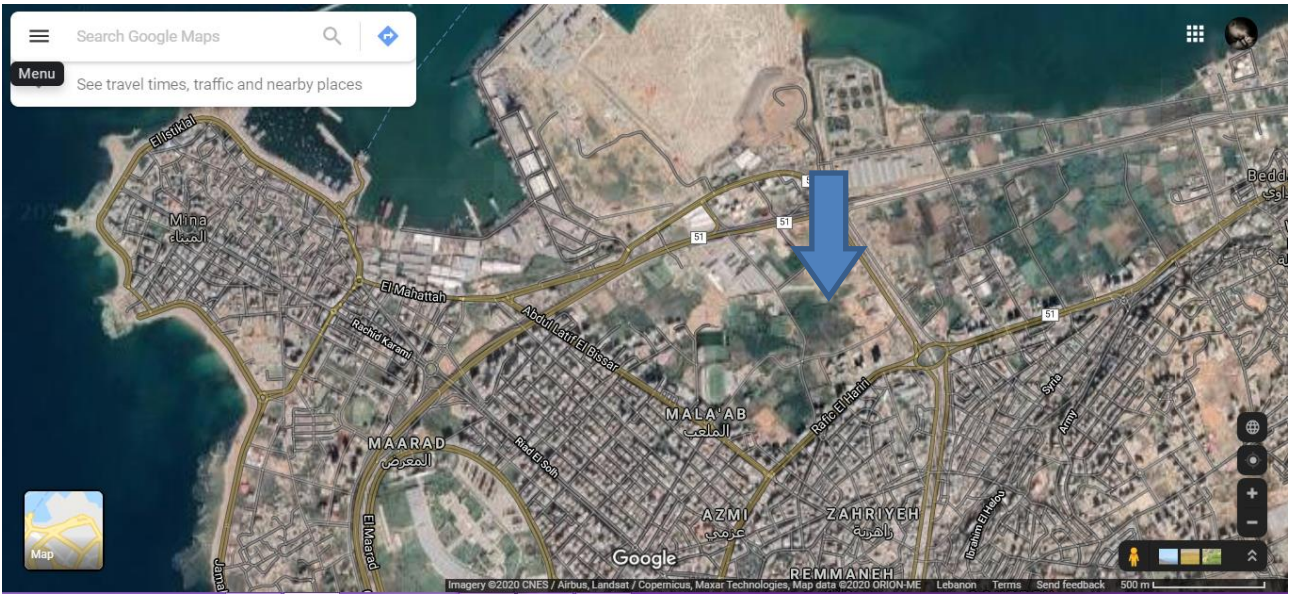

2.2 Buses Lines

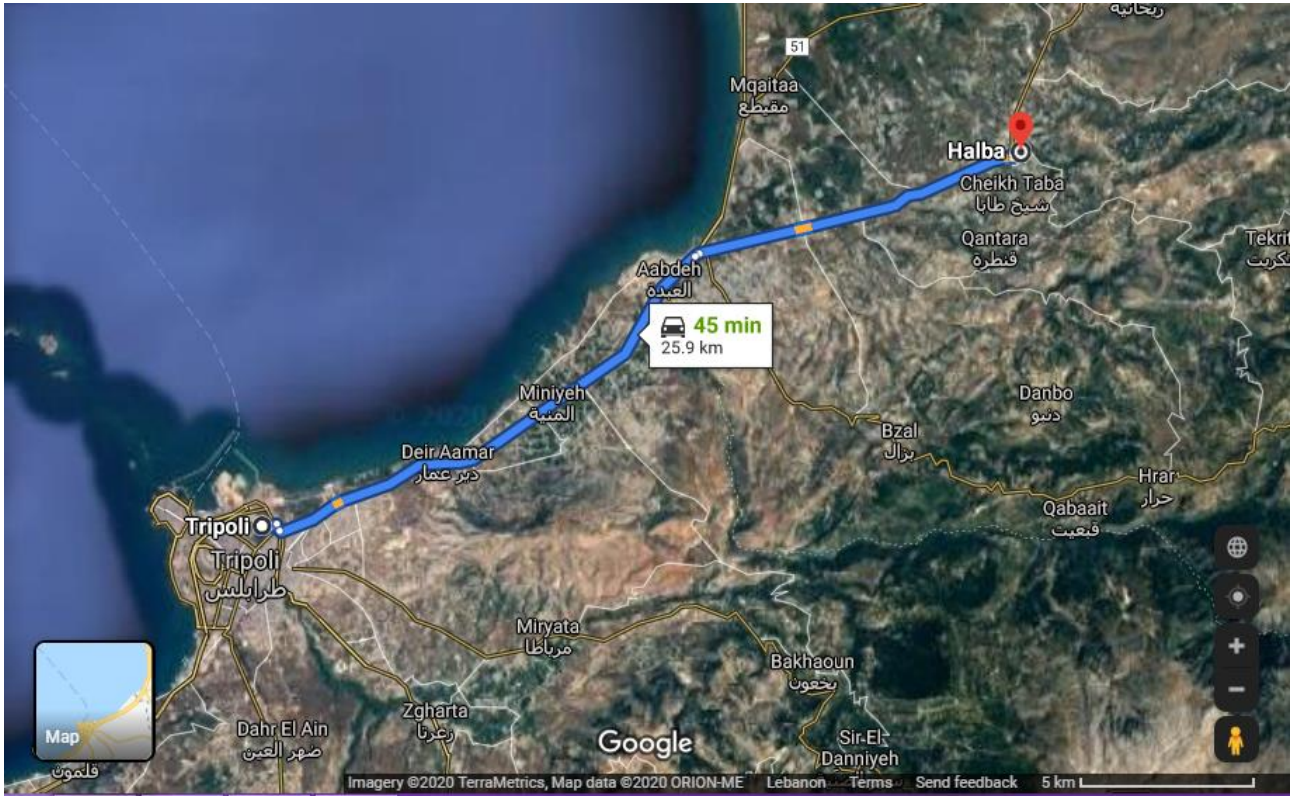

To Halba Akkar.

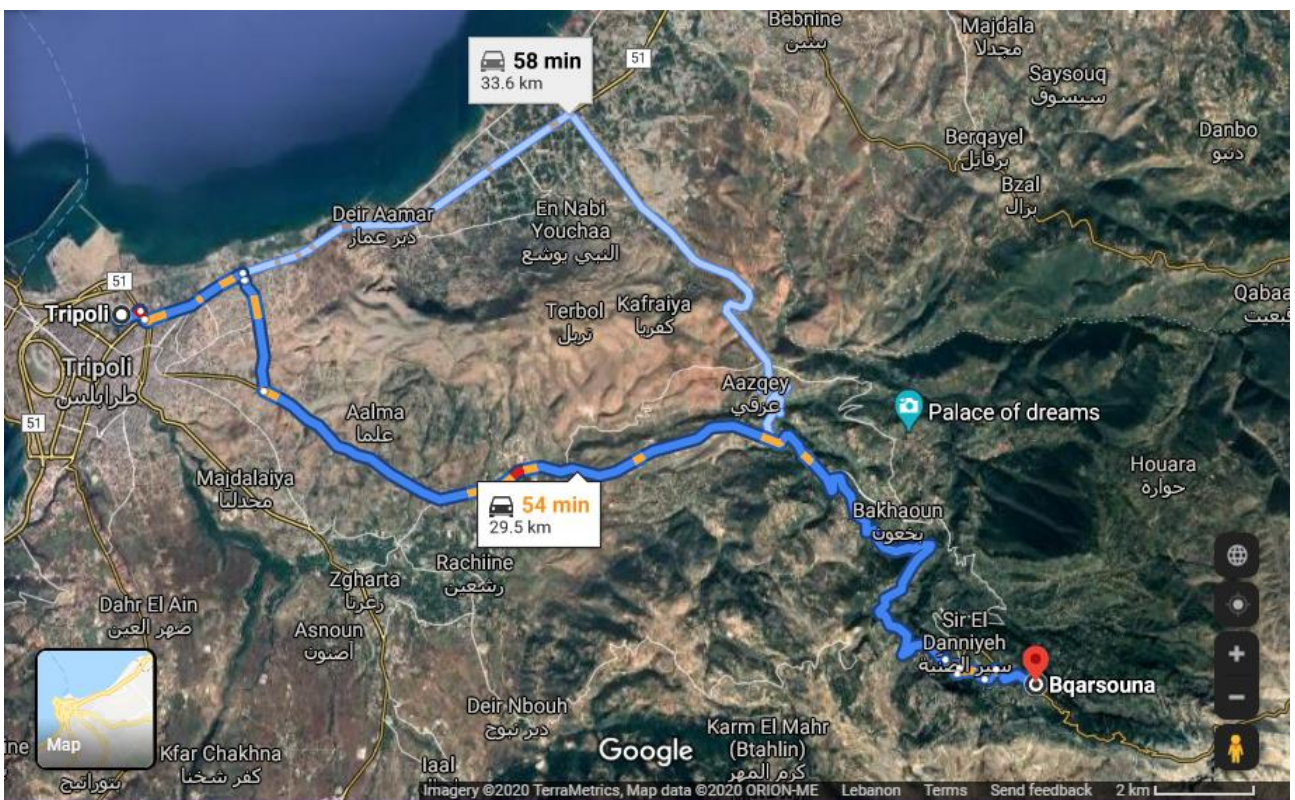

To Bqarsouna Danniyeh.

2.3 Bus Stop

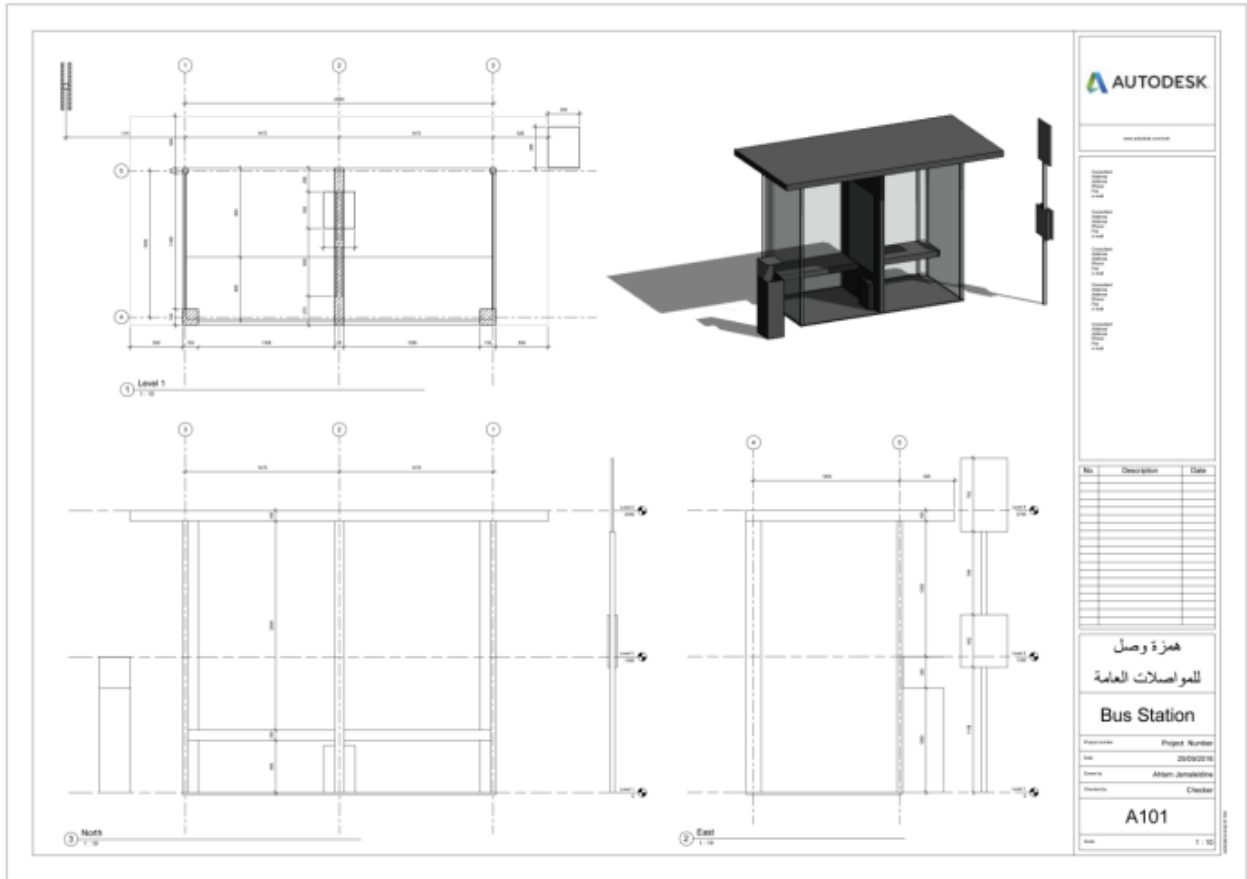

MODEL	QUANTIT Y	DIMENSION S	DESCRIPTIO N	PRIC E
	3	50x50x2500 (mm)	Steel beam	
	2	150x150x2500 (mm)	Steel beam	

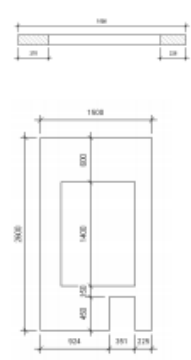
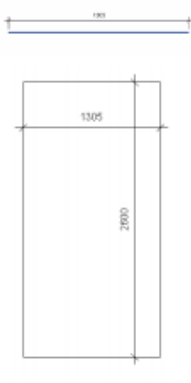
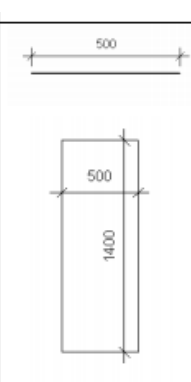
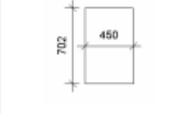
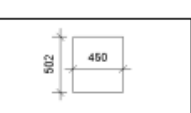
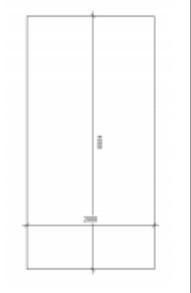
	1	150x1500x2500 mm	Steel panel	
	4	2x1300x2500 mm	Plexi glass	
	4	2x500x1400 mm	Glass	
	1	20x450x700 mm	Steel panel	
	2	20x450x500 mm	Steel panel	
	2	100x2000x4000 mm	Steel panel Floor and roof	

2.4 Bus Station Overview

